

J'AIME MA MAISON
.com

Portes

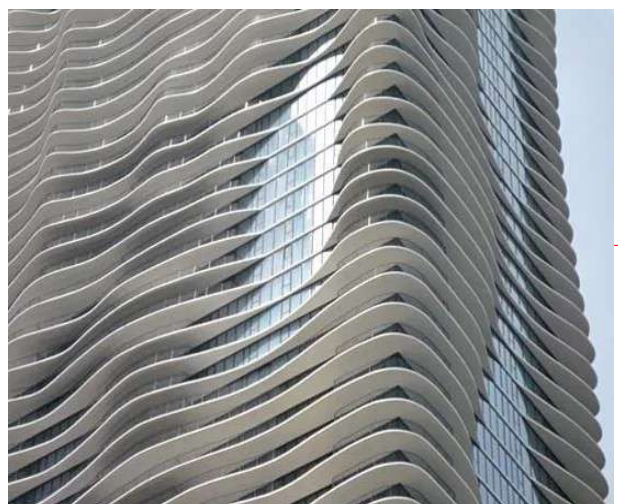
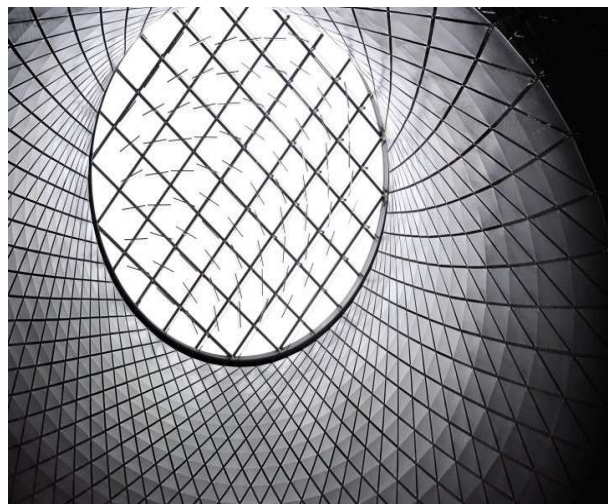
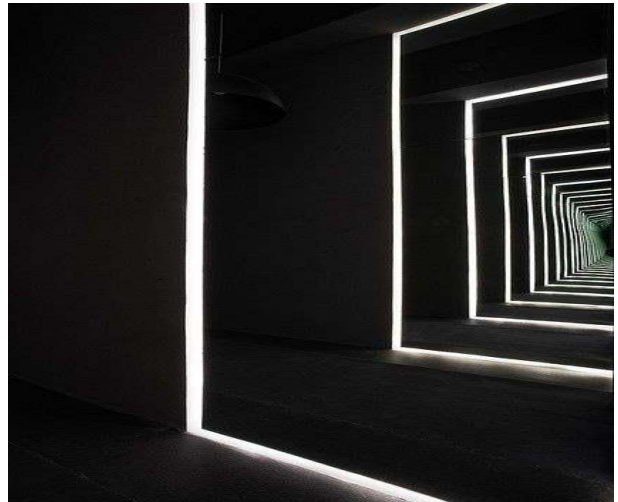

JAIMEMAMAISON.COM

PORTÉO-THERMIC

PORTE MONOBLOC



Up
0.79 W/m².K



INFORMATION TECHNIQUE

OUVRANT	DE 70 mm AVEC RUPTURE DE PONT THERMIQUE, TÔLE ALUMINIUM DE 3.0 MM
INTÉRIEUR	XPS DE HAUTE DENSITÉ kg/m^3 , RÉSISTANCE À LA COMPRESSION 300 kPa
DESIGN	5 GAMMES : LIGHT, WOOD, PURE, VINTAGE, NEO-RETRO
VITRAGE	TRIPLE VITRAGE 60MM
ACCESSOIRES	SELON MODÈLE
DIMENSIONS	STANDARD ET SUR MESURES
POIDS PAR VANTAIL	JUSQUE 250 KG
COEF	U_w 0,79 (Wirk)
ACOUSTIQUE	$R_w = 40$ dB.
ÉPAISSEUR PROFIL	2,0 mm



PERFORMANCE ACOUSTIQUE

VITRAGE: 64 mm.

AFFAIBLISSEMENT ACOUSTIQUE: $R_w = 40$ dB.

LIMITES DIMENSIONNELLES

PORTE PAUMELLES STANDARD

LARGEUR (L) = 1.300 mm

HAUTEUR (H) = 2.400 mm

PORTE PAUMELLES INVISIBLES

LARGEUR (L) = 1.150 mm

HAUTEUR (H) = 2.300 mm

RÉSULTATS BANC D'ESSAI

perméabilité à l'air (UNE-EN 12207:2000) : **Classe 4**

Étanchéité à l'eau (UNE-EN 12208:2000): **Classe 6A**

Résistance au vent (UNE-EN 12210:2000): **Classe C4**

Test de référence 1,20 x 2,30 m. 1 vantail.

Résistance aux impacts (UNE-EN 13049:2003): **Classe 5 (máx)**

Test de référence porte 1,80 x 2,20 m.

résistance aux ouvertures et fermetures répétées (UNE-EN 1191: 2.500.000 cycles)

Test de référence porte 0,935 x 2,20 m. 1 vantail

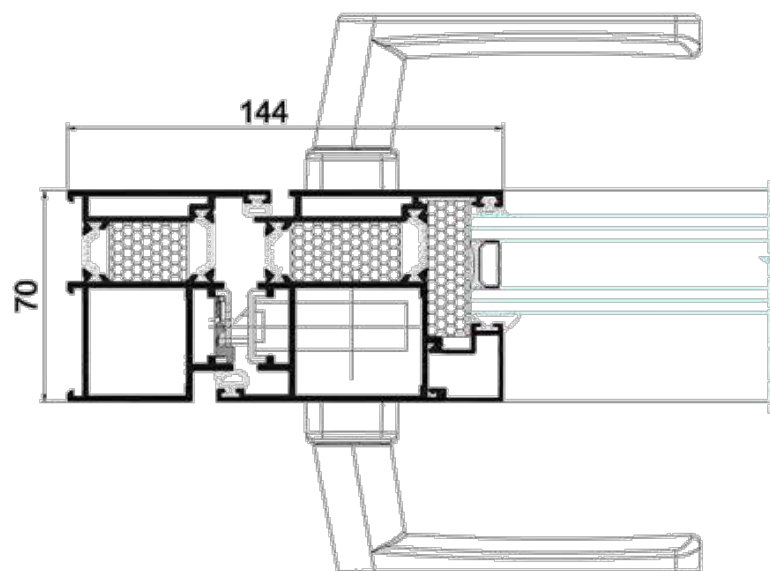



PORTÉO-PIVOT

PORTE MONOBLOC PIVOT



Up
0.79 W/m².K





INFORMATION TECHNIQUE

OUVRANT	DE 70 mm AVEC RUPTURE DE PONT THERMIQUE, TÔLE ALUMINIUM DE 3.0 MM
INTÉRIEUR	XPS DE HAUTE DENSITÉ kg/m^3 , RÉSISTANCE À LA COMPRESSION 300 kPa
DESIGN	5 GAMMES : LIGHT, WOOD, PURE, VINTAGE, NEO-RETRO
VITRAGE	TRIPLE VITRAGE 60MM
ACCESSOIRES	SELON MODÈLE
DIMENSIONS	STANDARD ET SUR MESURES
POIDS PAR VANTAIL	JUSQUE 220 KG
COEF	U_w 0,8 (W/mK)
ACOUSTIQUE	R_w = 40 dB.
ÉPAISSEUR PROFIL	2,0 mm

PORTÉO

PERFORMANCE ACOUSTIQUE

VITRAGE: 64 mm.

AFFAIBLISSEMENT ACOUSTIQUE: $R_w = 40$ dB.

LIMITES DIMENSIONNELLES

PORTE PIVOT

LARGEUR (L) = 1.700 mm

HAUTEUR (H) = 3.000 mm

RÉSULTATS BANC D' ESSAI

perméabilité à l'air (UNE-EN 12207:2000) : **Classe 4**

Étanchéité à l'eau (UNE-EN 12208:2000): **Classe 5A**

Résistance au vent (UNE-EN 12210:2000): **Classe C5**

Test de référence 1,20 x 2,00 m. 1 vantail.

Résistance aux impacts (UNE-EN 13049:2003): **Classe 5 (máx)**

Test de référence porte 1,80 x 2,20 m.

résistance aux ouvertures et fermetures répétées (UNE-EN 1191: 2.500.000 cycles)

Test de référence porte 0,935 x 2,20 m. 1 vantail

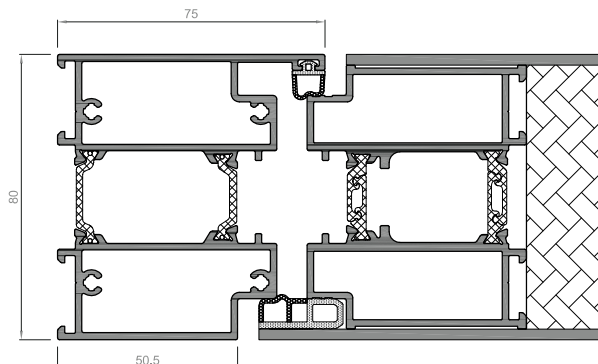

PORTÉO

TYPES D'OUVERTURES

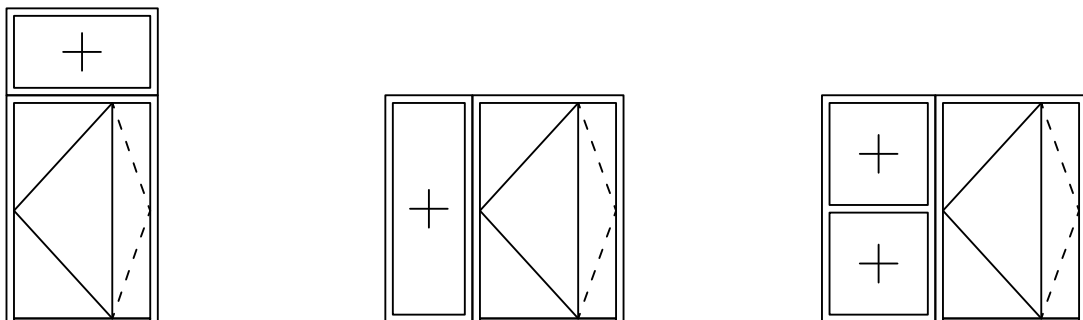
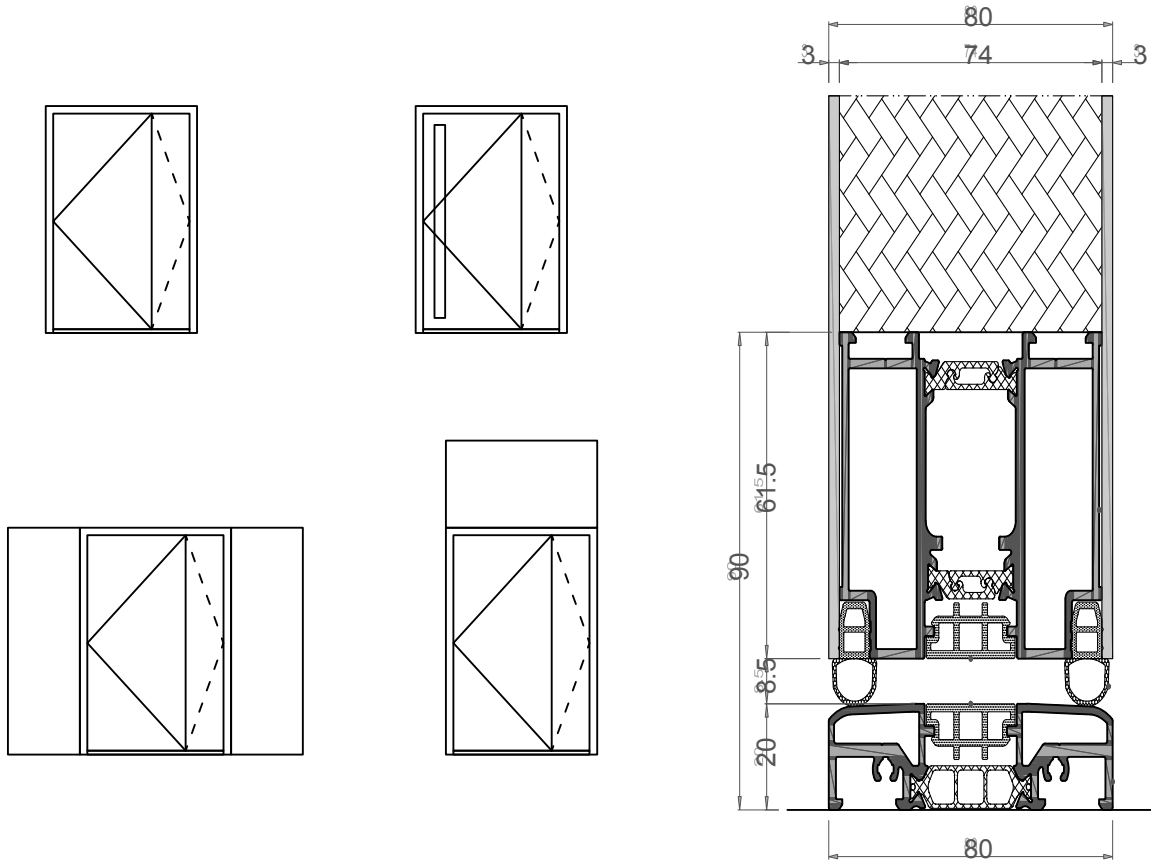

GLASSLINE

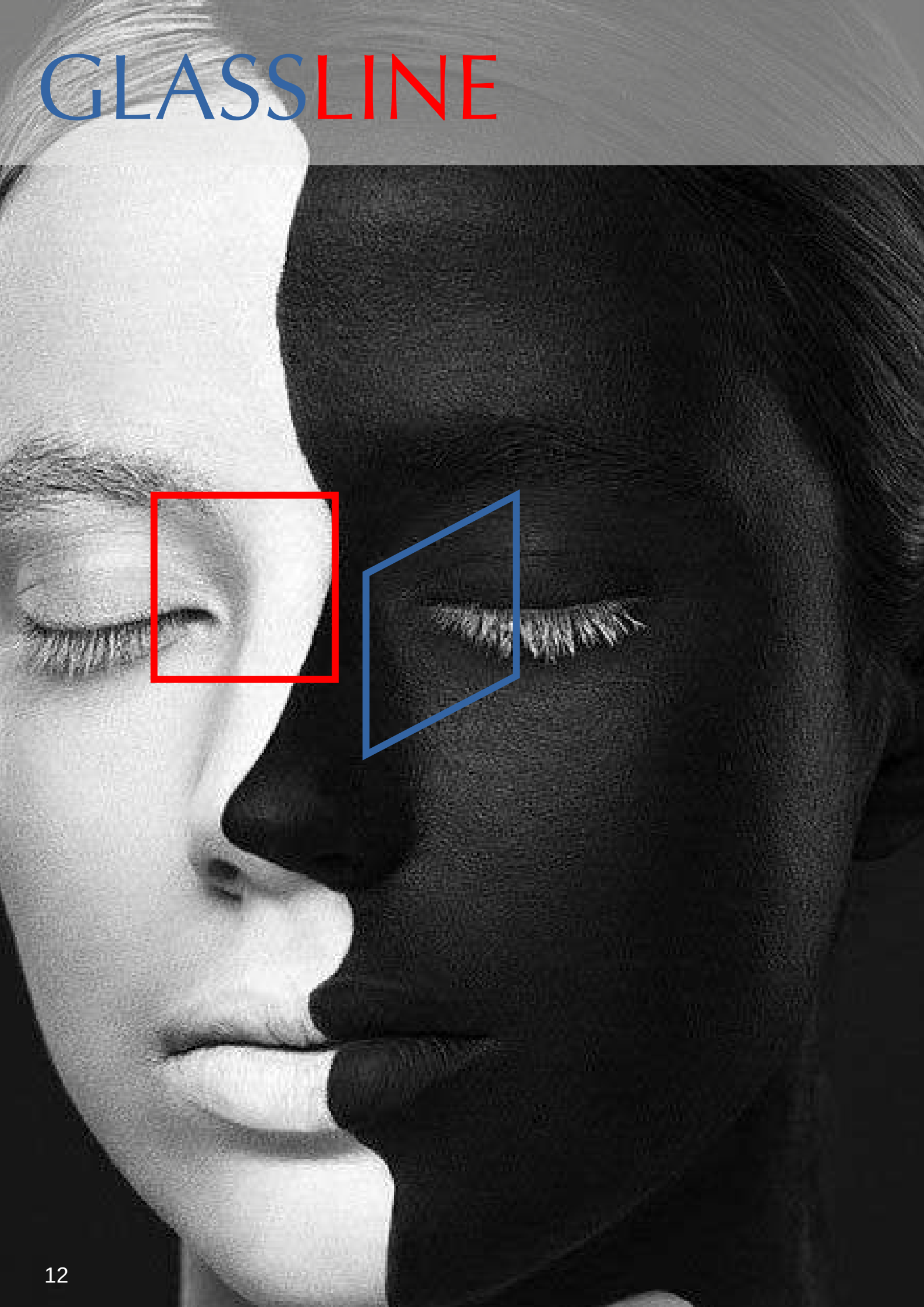



DÉTROIT



DÉTROIT | GLASSLINE

Porte ral 9005 texturé

Planilaque 6 mm noir

Triple vitrage de 60 mm standard

Barre de tirage modèle d-09

Serrure 3 ou 5 points winkhaus hook pilot

Seuil pmr

Barillet de sécurité avec carte de propriété

Possibilité:

- de bicoloration
- planilaque blanc
- plaxage
- poignée intégrée avec ou sans leds





WASHINGTON



WASHINGTON | GLASSLINE

Porte ral 9005 texturé
Planilaque 6 mm noir
Triple vitrage de 60 mm standard
Barre de tirage modèle d-03
Serrure 3 ou 5 points winkhaus hook pilot
Seuil pmr
Barillet de sécurité avec carte de propriété

Possibilité:

- de bicoloration
- planilaque blanc
- plaxage
- poignée intégrée avec ou sans leds

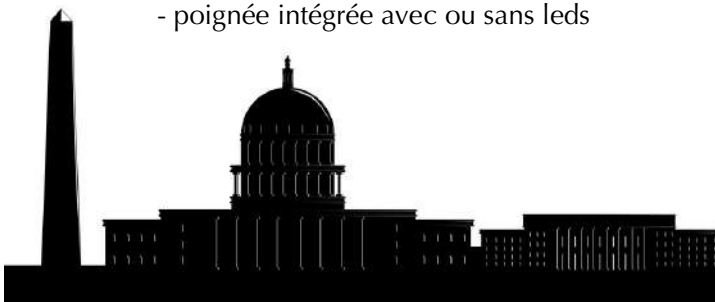



GLASSLINE



DETROIT



WASHINGTON



MIAMI



ORLANDO



DAYTONA



NEW YORK



ESQUISSE

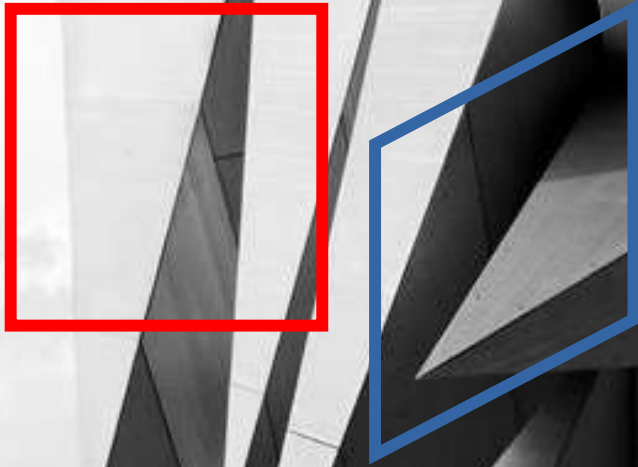

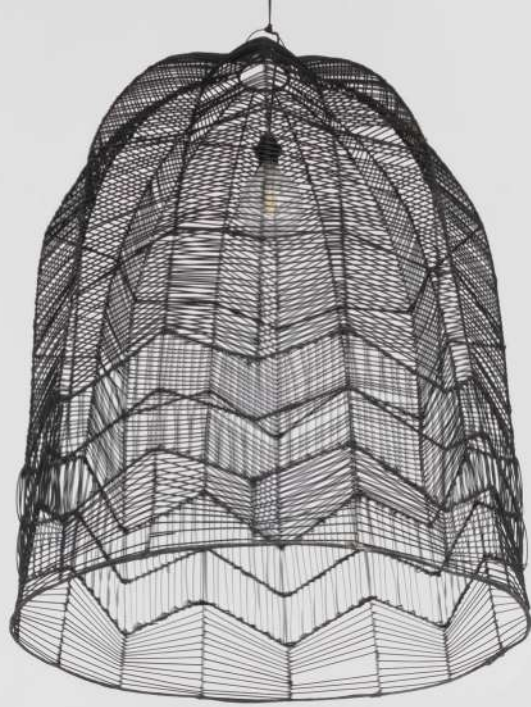

GUAZZO





GUAZZO | ESQUISSE

Porte monobloc ral 9005 texturé
Déco latéral sahara concrète
Triple vitrage 60 mm
Barre de tirage intégrée 9005
Serrure 3 ou 5 points winkhaus
Seuil PMR

Options:

- Bicoloration
- Déco filmé (voir couleurs)
- Poignée intégrée avec leds



NOCTURNE



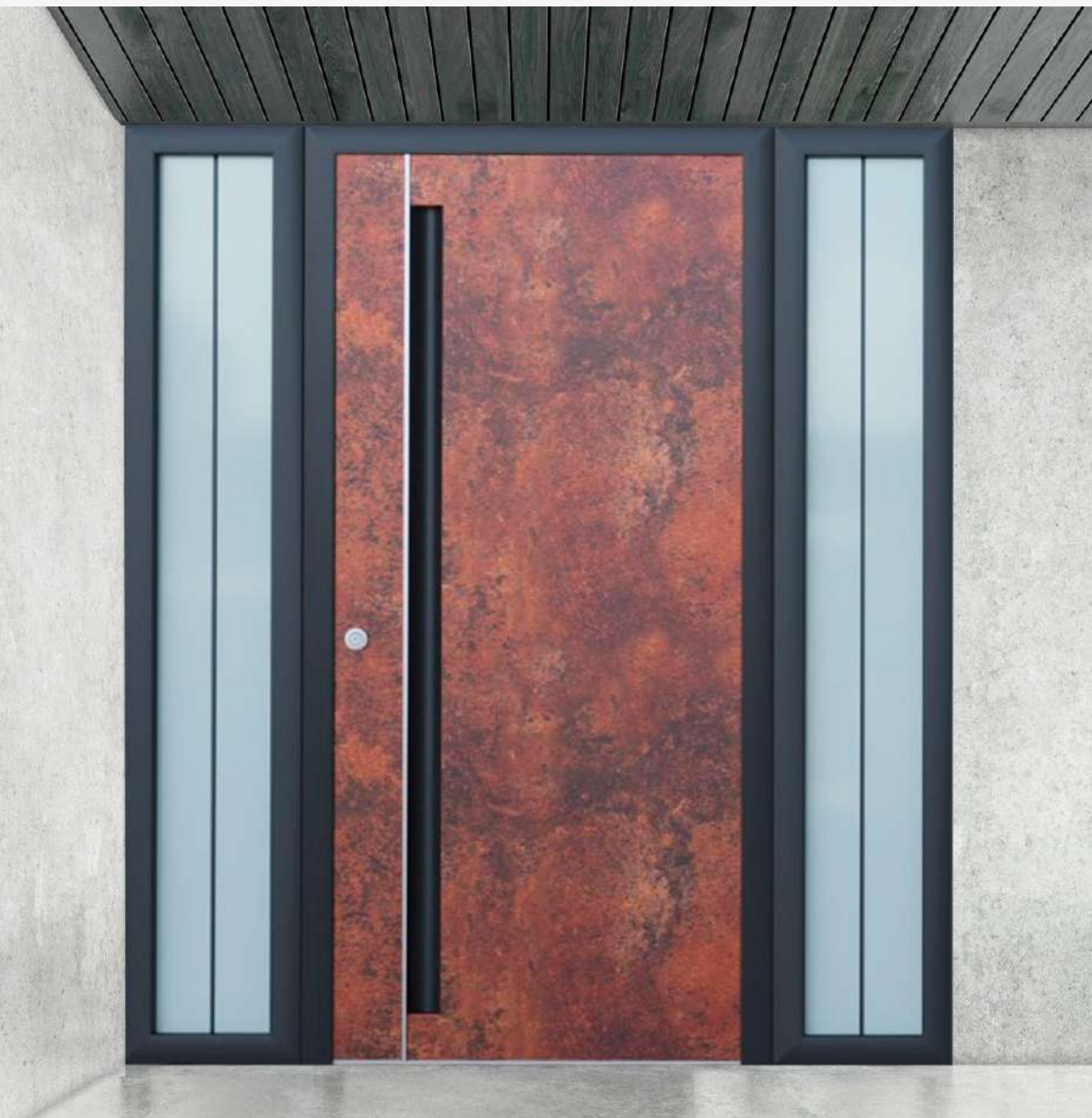

NOCTURNE | ESQUISSE

Porte monobloc sahara rust
Déco inox verticale
Porte ouvrant 76mm
Barre de tirage intégrée 9005
Serrure 3 ou 5 points winkhaus
Seuil PMR

Options:

- Bicoloration
- Filme bois et couleurs
- Poignée intégrée avec leds



ESQUISSE



GUAZZO



NOCTURNE



CONCRÈTE



DIURNE



PRIMA



ESTOMPE



TEMPERA



LUMIA



SOMBRIA



CALAME



ROMBO





ZENLINE



GIFU

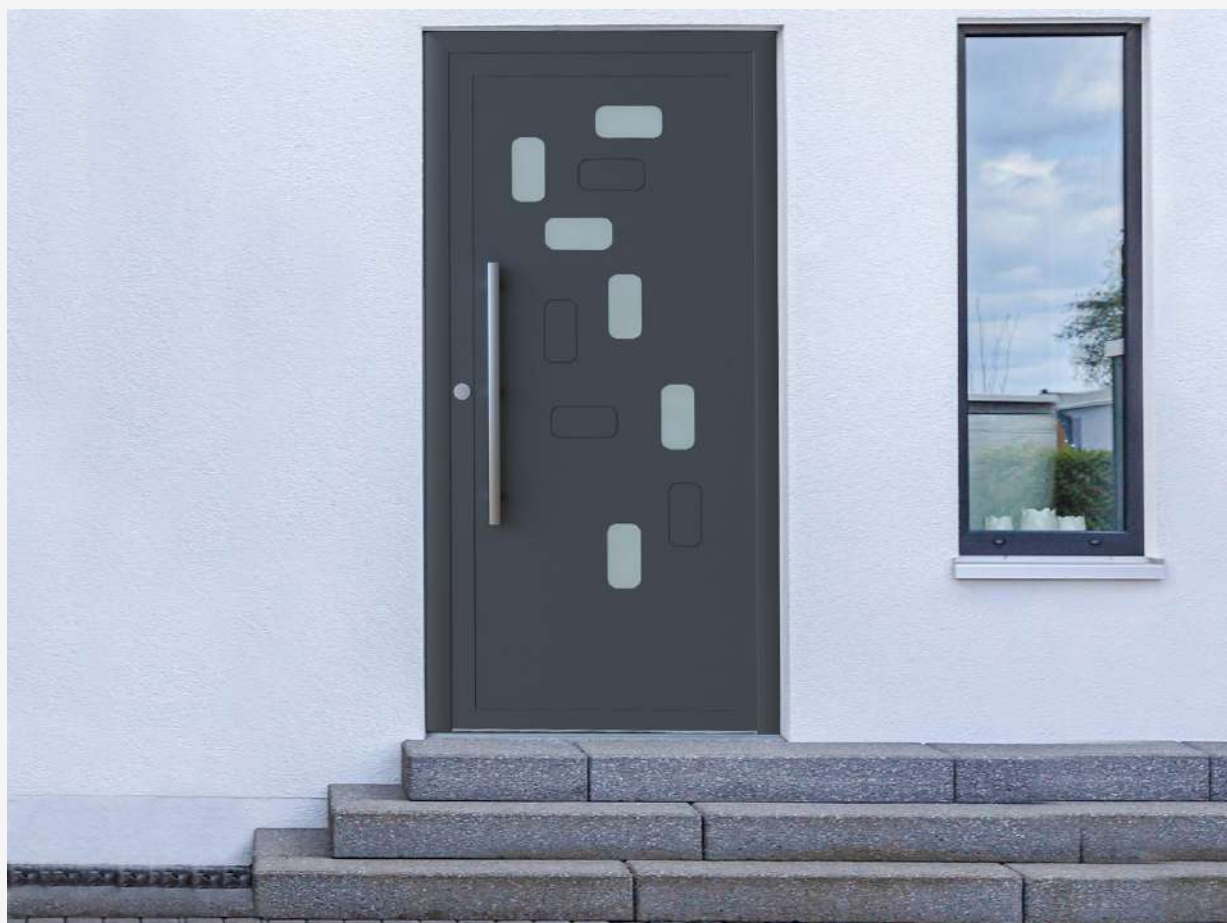

GIFU | ZEN LINE

Porte monobloc ral 7016 texturé

Vitrage dépoli

Porte ouvrant 76mm

Barre de tirage D17

Serrure 3 ou 5 points winkhaus

Seuil PMR

Options:

- Bicoloration
- Poignée intégrée





SENDEI



SENDEI | ZEN LINE

Porte monobloc ral 7016 texturé
Vitrage dépoli
Porte ouvrant 76mm
Barre de tirage D-17
Serrure 3 ou 5 points winkhaus
Seuil PMR

Options:
- Bicoloration
- Poignée intégrée

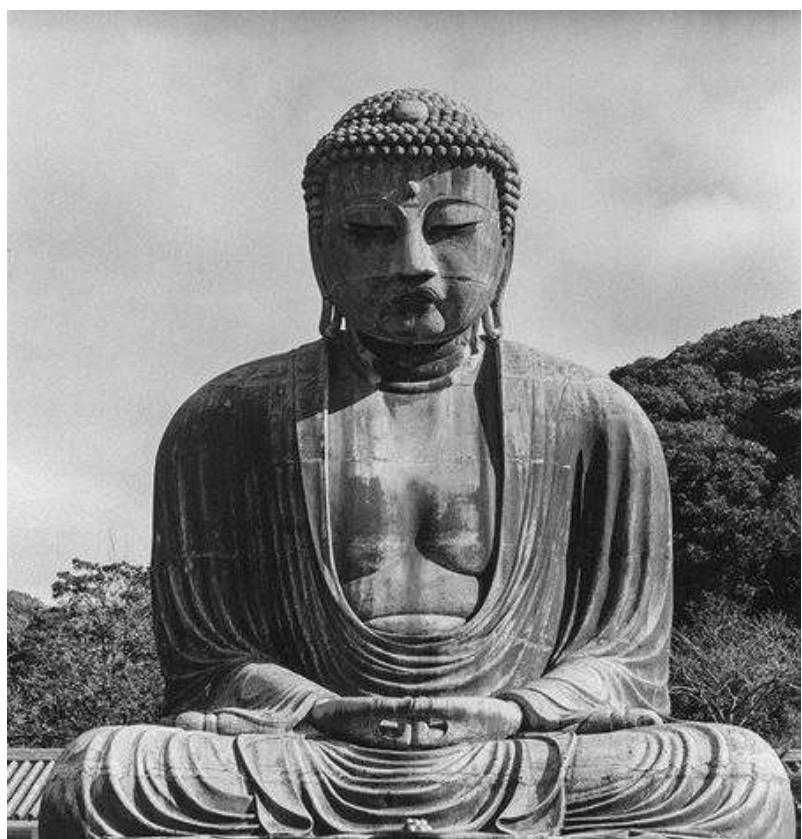



ZENLINE



GIFU



SAKAI



SAPPORO



NAGANO



SENDEI



TOYAMA



AMORI



TOKYO

ARGENTINA

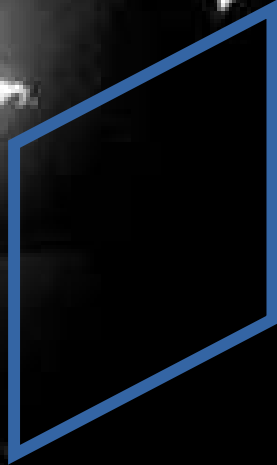
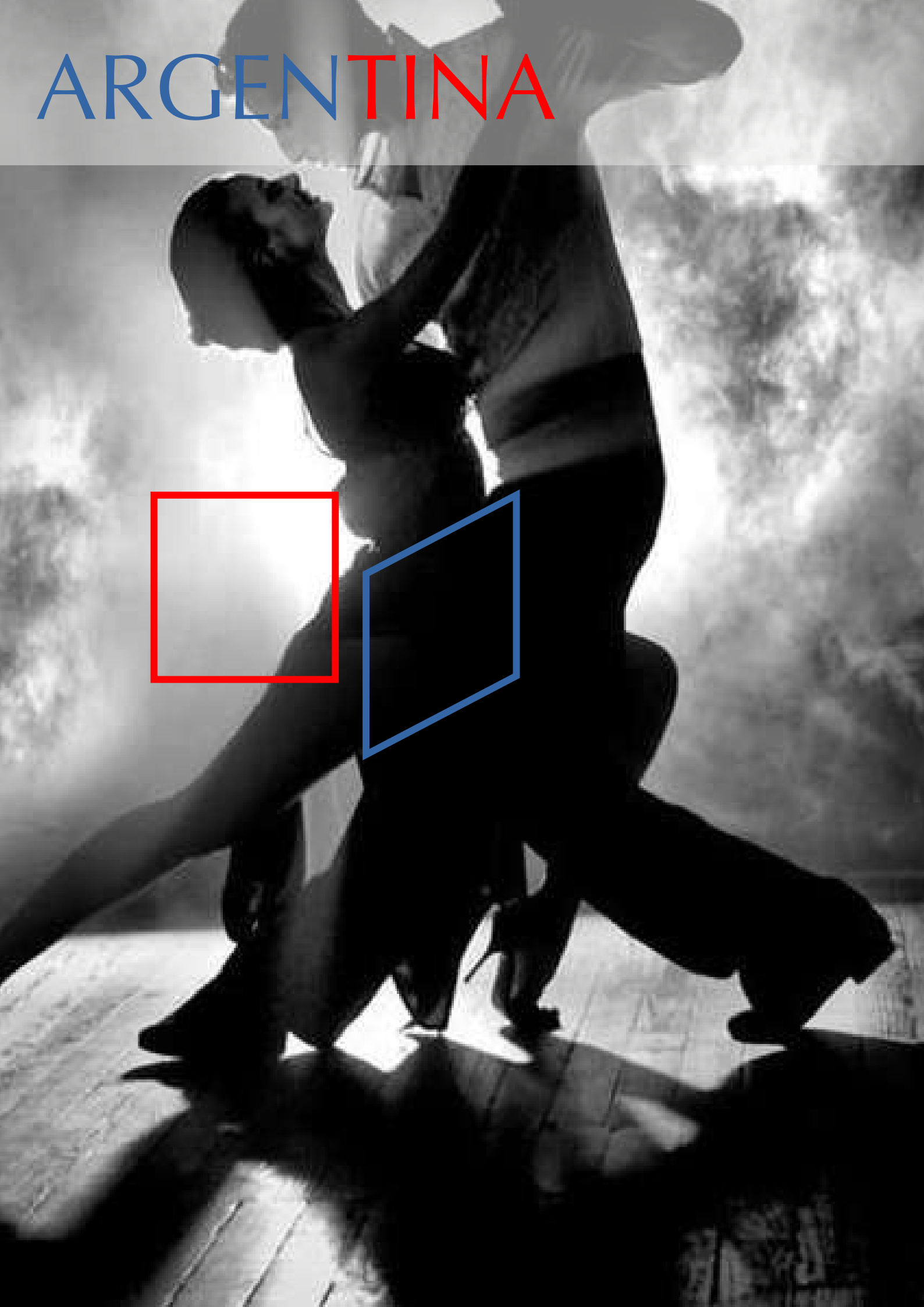



PLATA



USHUAIA



BARILOCHE



BUENOS AIRES



CALAFATE



ROSARIO



TUCUMAN



VALDES



PLATA | ARGENTINA

Porte monobloc ral 9005 texturé
Déco inox
Vitrage dépoli avec ligne noire
Porte ouvrant 76mm
Barre de tirage D-19
Serrure 3 ou 5 points winkhaus
Seuil PMR

Options:

- plaxage
- Bicoloration
- Poignée intégrée



PLATA





USHUAIA | ARGENTINA

Porte monobloc ral 7016 texturé
Déco inox
Vitrage dépoli
Porte ouvrant 76mm
Barre de tirage D-20
Serrure 3 ou 5 points winkhaus
Seuil PMR

Options:

- plaxage
- Bicoloration
- Poignée intégrée



USHUAIA



NATURÉO

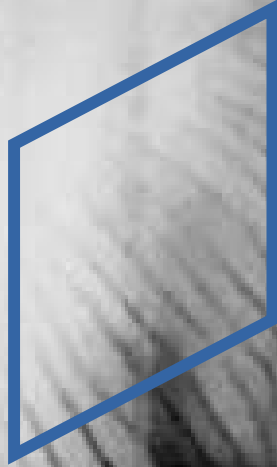
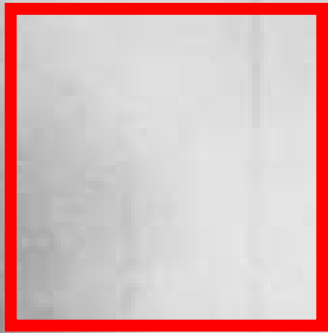





MARTIGNY | NATURÉO

Porte monobloc film winchester
Vitrage dépoli lignes noires
Porte ouvrant 76mm
Barre de tirage D-17 ral 9005
Serrure 3 ou 5 points winkhaus
Seuil PMR

Options:

- plaxage
- Bicoloration
- Poignée intégrée



MARTIGNY





BADEN BADEN | NATURÉO

Porte monobloc ral 9005 texturé
Vitrage dépoli
Déco GO chene doré
Porte ouvrant 76mm
Barre de tirage D-17 (800 ral 9005)
Serrure 3 ou 5 points winkhaus
Seuil PMR

Options:

- plaxage
- Bicoloration
- Poignée intégrée



BADEN BADEN



NATURÉO



BADEN BADEN



BÂLE



DORTMUND



FRANCFORT



GENÈVE



HAMBOURG



HANOVRE



LINZ



MARTIGNY



MUNICH



ROSTOCK



SALZBOURG



STUTGART



VIENNE



BASEL



GLARIUS



JURA



VALAIS



VAUD

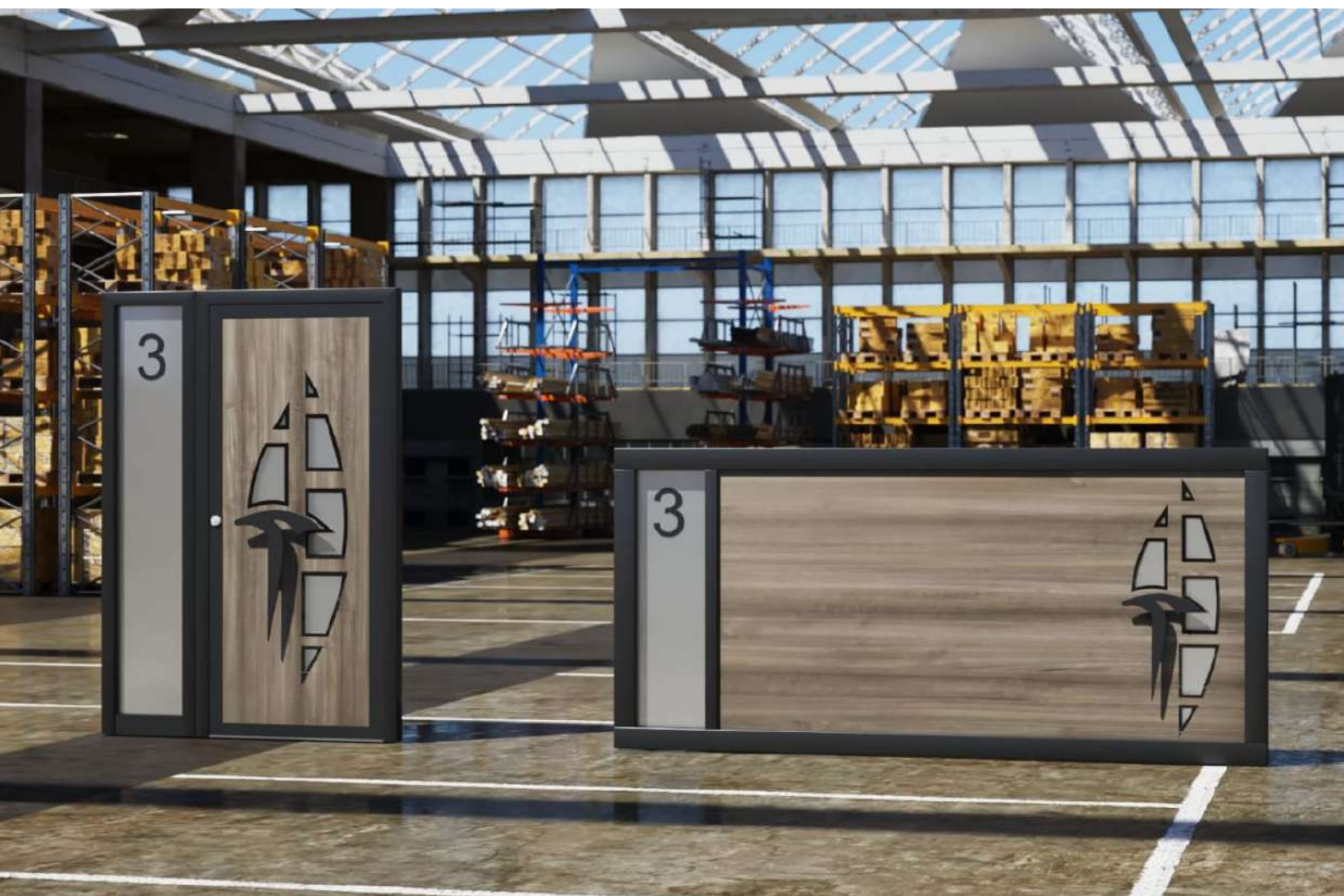



12

12

LIGHT DESIGN

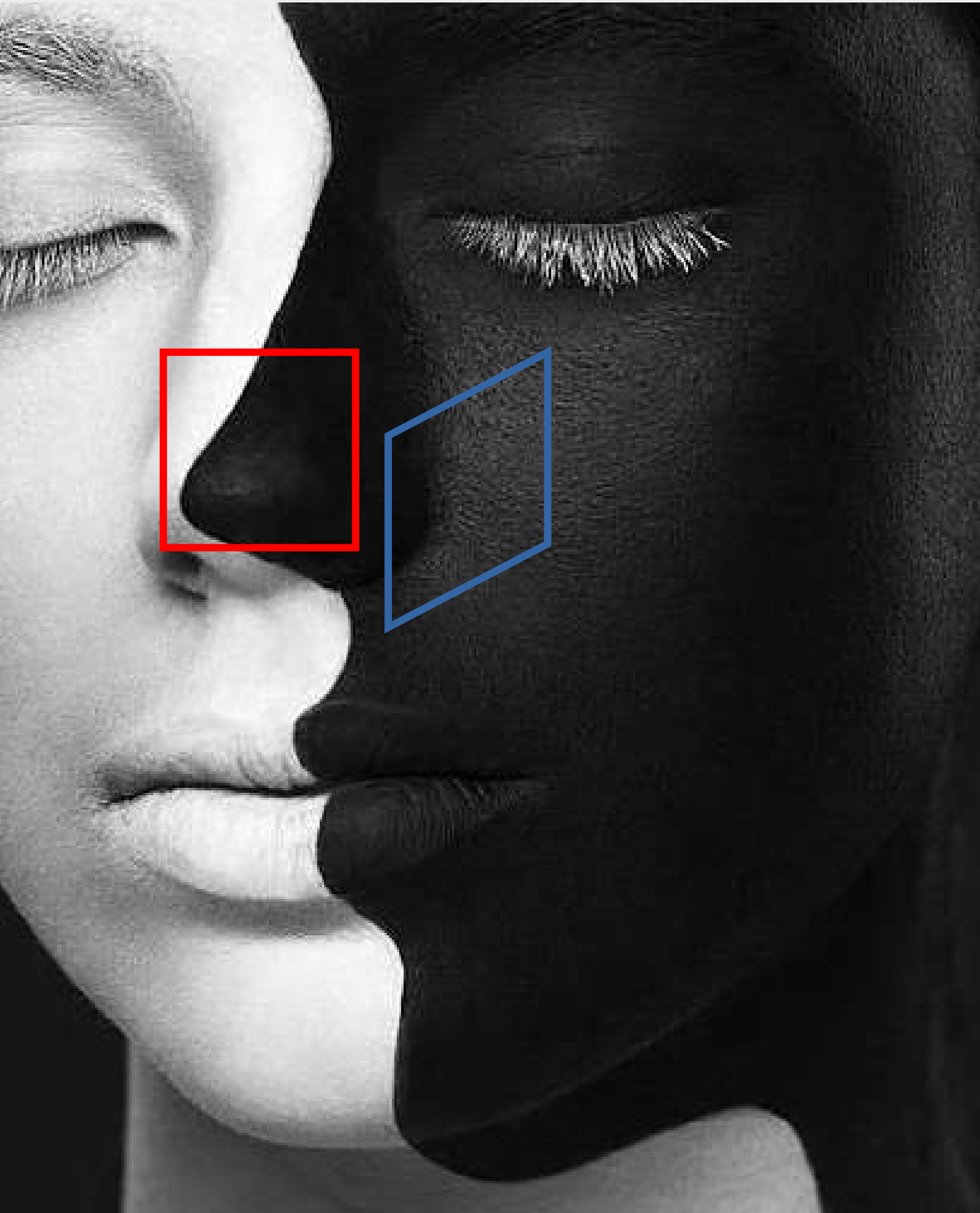

GÖTEBORG

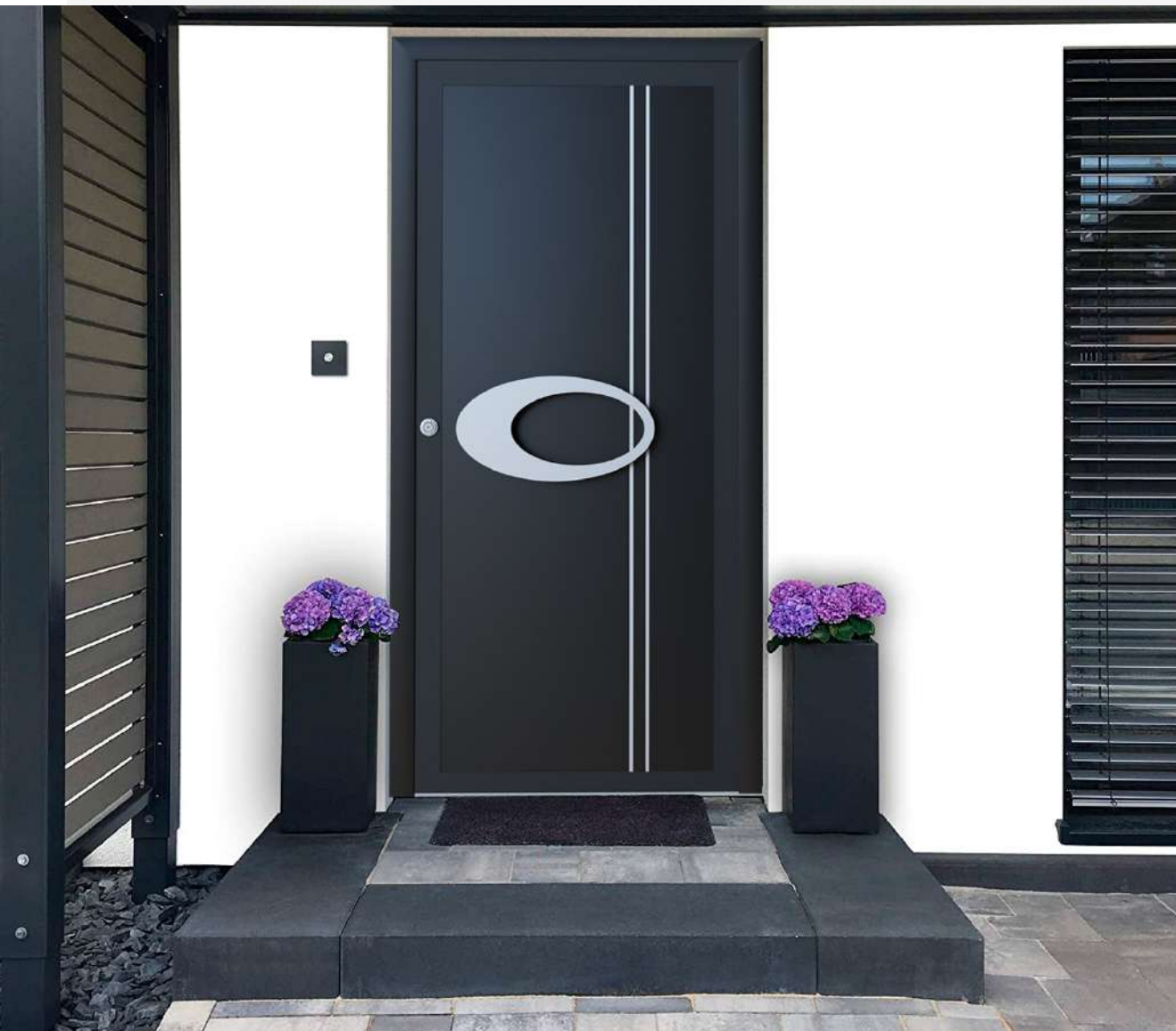

GÖTEBORG | LIGHT DESIGN

Porte monobloc ral 9005 texturé
Déco inox
Porte ouvrant 76mm
Barre de tirage D-14
Serrure 3 ou 5 points winkhaus
Seuil PMR

Options:

- plaxage
- Bicoloration
- Poignée intégrée





MALMÖ



MALMÖ | LIGHT DESIGN

Porte monobloc ral 9005 texturé

Déco inox

Porte ouvrant 76mm

Barre de tirage D-09

Serrure 3 ou 5 points winkhaus

Seuil PMR

Tierce vitrage déco lignes noires

Options:

- plaxage
- Bicoloration
- Poignée intégrée







GÖTEBORG



BERGEN



BORAS



GÄVLE



KALMAR



HELSINKI



LUND



MALMÖ

VITROLINE

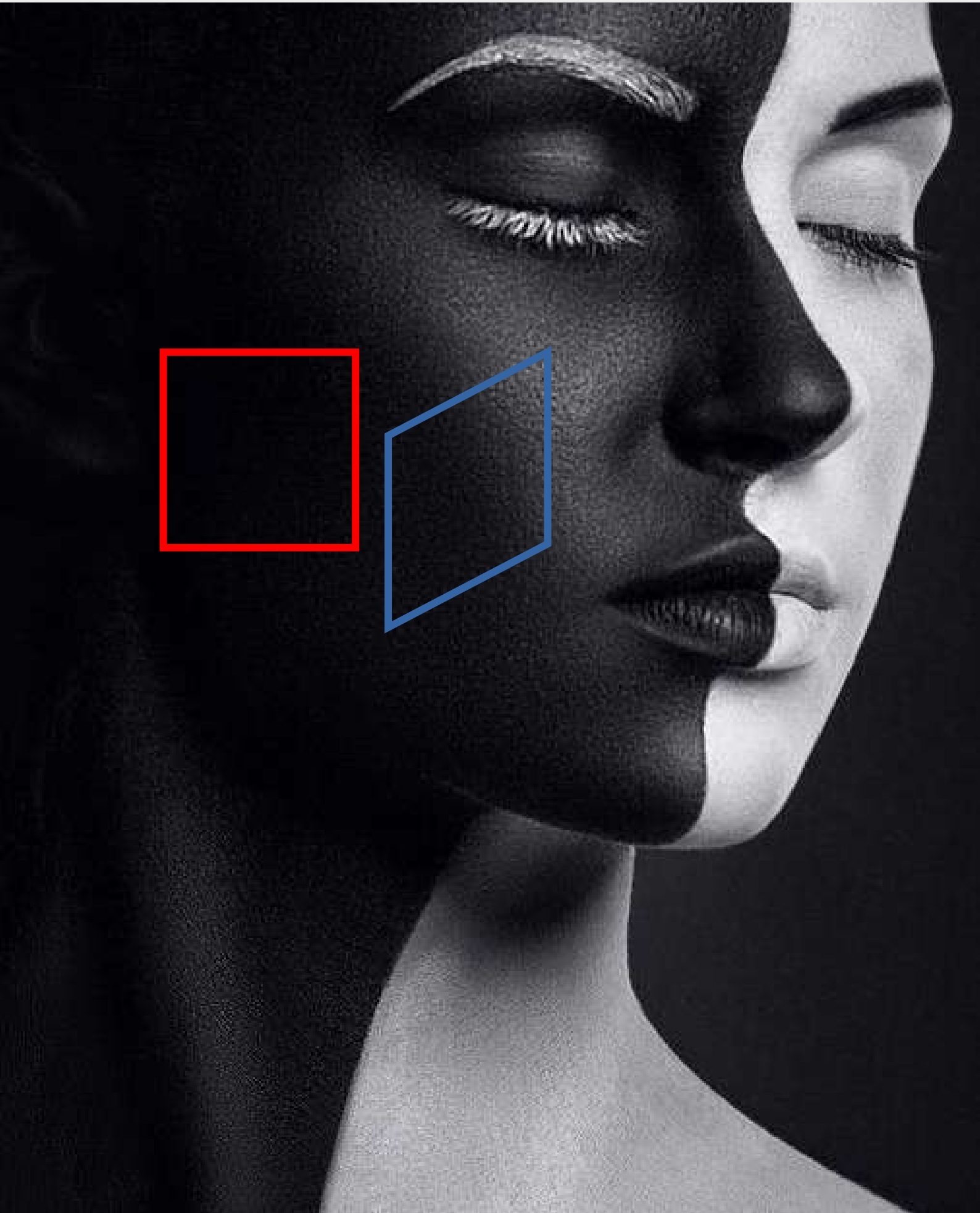



OPORTO



OPORTO | VITROLINE

Porte chassis ral 7016 texturé

Verre mat déco noir 40mm

Porte ouvrant 76mm

Barre de tirage sur ouvrant

Serrure 3 ou 5 points winkhaus

Seuil PMR

Option fixe avec reprise du décor

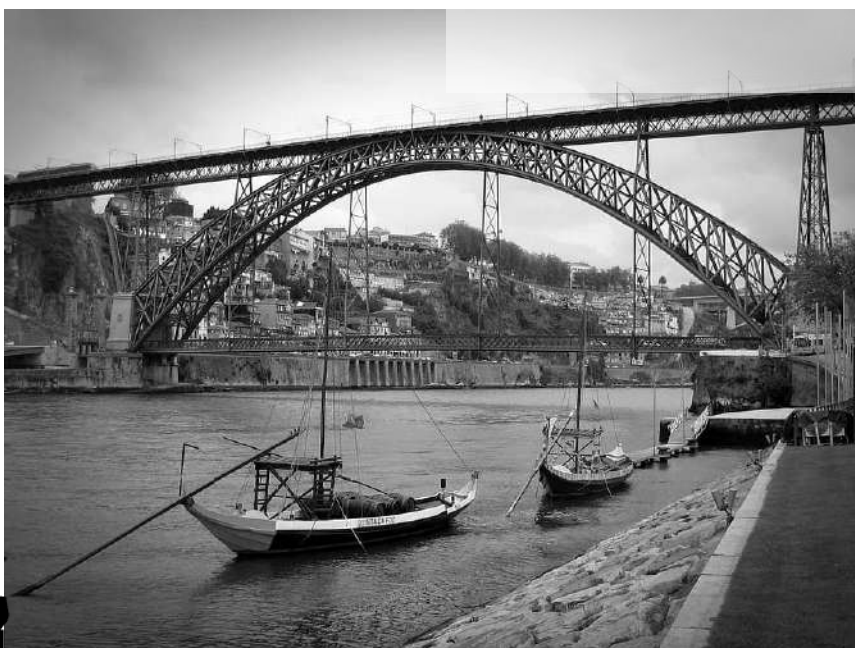



LISBOA



LISBOA | VITROLINE

- Porte chassis ral 7016 texturé
- Verre mat déco noir 40mm
- Porte ouvrant 76mm
- Barre de tirage sur ouvrant
- Serrure 3 ou 5 points winkhaus
- Seuil PMR
- Option fixe avec reprise du décor





VITROLINE



OPORTO



LISBOA



COIMBRA



FARO



SETUBAL



SINTRA

EXCLUSIV DESIGN

Le concept de cette serie et d'ouvrir la finition de votre porte à votre imagination.

Grace à nos machines de dernieres génération d'impression numérique ou digital céramique sur verre, nous pouvons vous proposer tout types de décors afin de faire de votre porte un objet unique, une oeuvre d'art.



ALBUFEIRA



GAIA



OBIDOS



SINTRA



VALENÇA



OPORTO

VINTAGE





72

LIÈGE





LIÈGE | VINTAGE LINE

Porte ral 9005 texturé
Verre petits bois inox
Porte ouvrant 76mm
Barre de tirage D-19
Serrure 3 ou 5 points winkhaus
Seuil PMR

Options:

- Rals
- Bicoloration
- Rosace décorative
- Cimaises



VINTAGE



LIÈGE



AMSTERDAM



HEIDOVEN



BREDA



HAARLEM



LA HAYE



ROTTERDAM



UTRECHT



VENLO



LEEUWARDEN



EDE



NÉORÉTRO





72

BIRMINGHAM



BIRMINGHAM | NÉO - RÉTRO

Porte ral 9005 texturé
Verre grille 4
Porte ouvrant 76mm
Barre de tirage D-19
Serrure 3 ou 5 points winkhaus
Seuil PMR

Options:

- Rals
- Bicoloration
- Rosace décorative

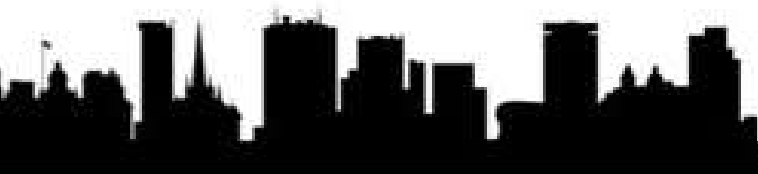



NÉO RÉTRO



LONDRES



EDIMBOURG



MANCHESTER



BRISTOL



CARDIFF



BIRMINGHAM



GLASGOW



LIVERPOOL



36

ACCESSOIRES PORTES

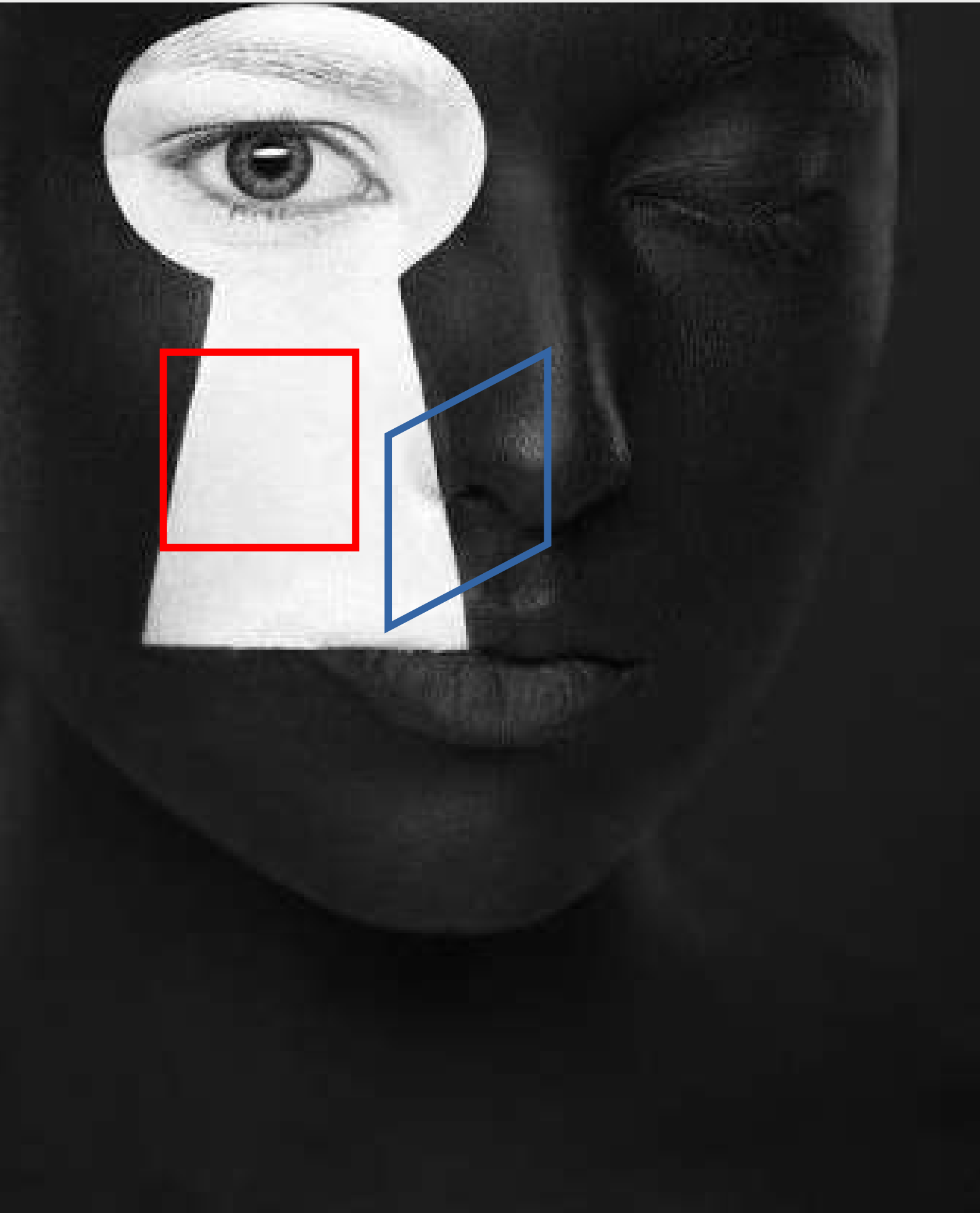





Always precise **WINKHAUS**

SERRURE



ALUPRO À FAIT LE CHOIX DE WINKHAUS RECONNU POUR SA FIABILITÉ ET COMPÉTENCE EN MATIÈRE DE SÉCURITÉ.

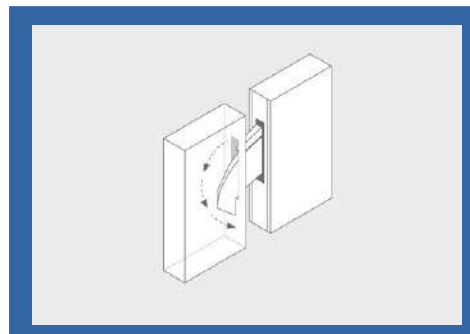



Always precise **WINK HAUS**

HOOKLOCK M :

Quelle plénitude de savoir que la porte est quand-même sécurisée lorsque l'on a oublié de la fermer à clé. Le verrouillage multipoints manuel hooklock m pardonne la négligence de l'utilisateur lorsqu'il oublie de verrouiller car, comme son nom l'indique, verrouille automatiquement. L Fermer la porte. C'est tout !

Hooklock M de Winkhaus est un système de verrouillage multipoints équipé de verrous crochets indépendants entre eux pour un griffage arrière impeccable et d'éléments d'étanchéité pour une compression dynamique.

Dès que l'on ferme la porte, un dispositif magnétique situé sur le dormant déclenche l'actionnement des éléments d'étanchéité et des verrous crochets massifs pour que la porte soit sécurisée contre les accès indésirables. Ils basculent automatiquement. La porte est ainsi toujours bien verrouillée et solidaire du dormant sans verrouillage supplémentaire.

Les verrous à crochets massifs, les éléments d'étanchéité et le pêne peuvent être déverrouillés manuellement par l'intermédiaire du cylindre de fermeture ou de la béquille.

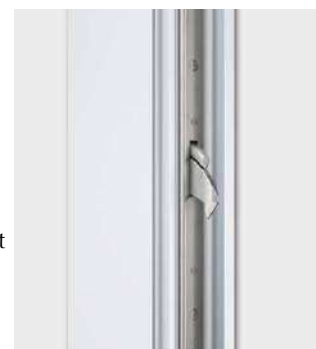

POIGNÉES STANDARD



ESTHÉTIQUE DROITE | STRAIGHT AESTHETIC

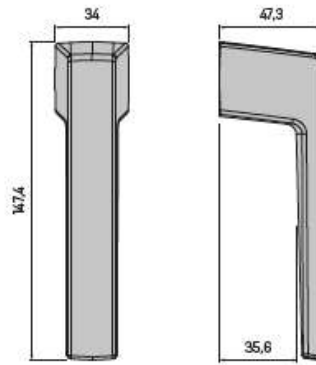

ESTHÉTIQUE COURBE | CURVED AESTHETIC

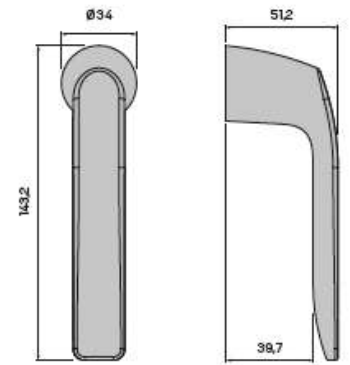

BARRES DE TIRAGE STANDARD

C-1400 C-1000 C-800 C-600 C-500 C-400 C-300

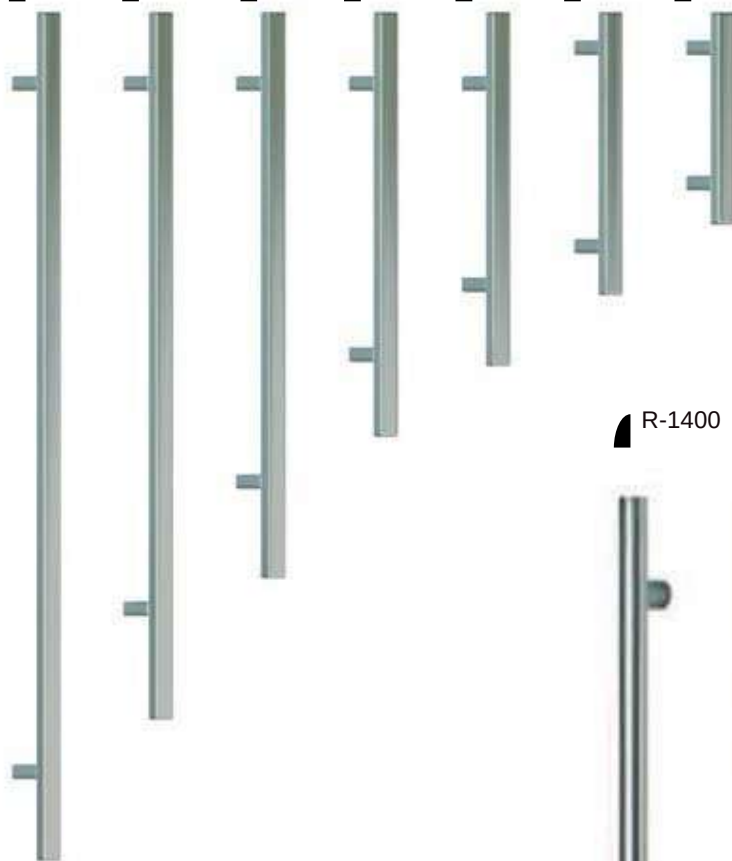

← Cuadro

R-1400 R-1000 R-800 R-600 R-500 R-300



Rondo →

440MM



DÉCO 1

505MM



DÉCO 2

300MM



DÉCO 3

670MM



DÉCO 4

870MM

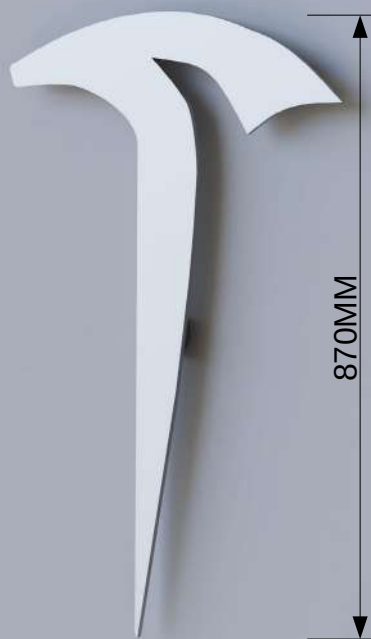

DÉCO 5

870MM



DÉCO 6

650MM



DÉCO 7

400MM



DÉCO 8

550MM



DÉCO 9

500MM



DÉCO 10

EXCLUSIV

BARRE DE TIRAGE

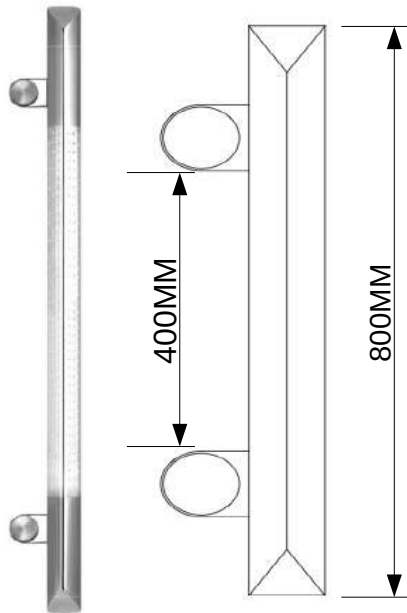

Eclusiv 1

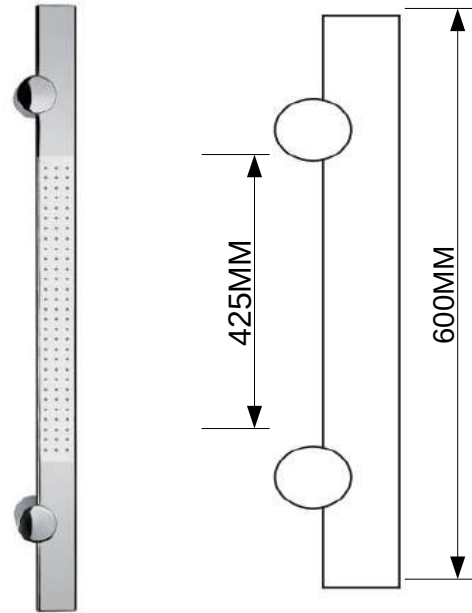

Eclusiv 2



Eclusiv 3

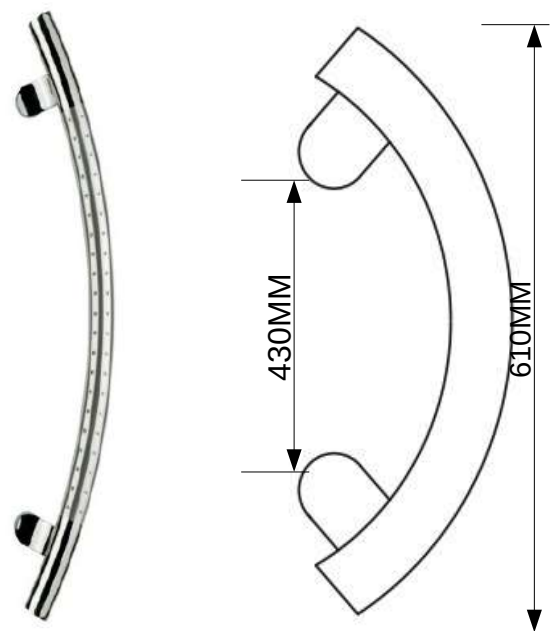

Eclusiv 4

EXCLUSIV 5

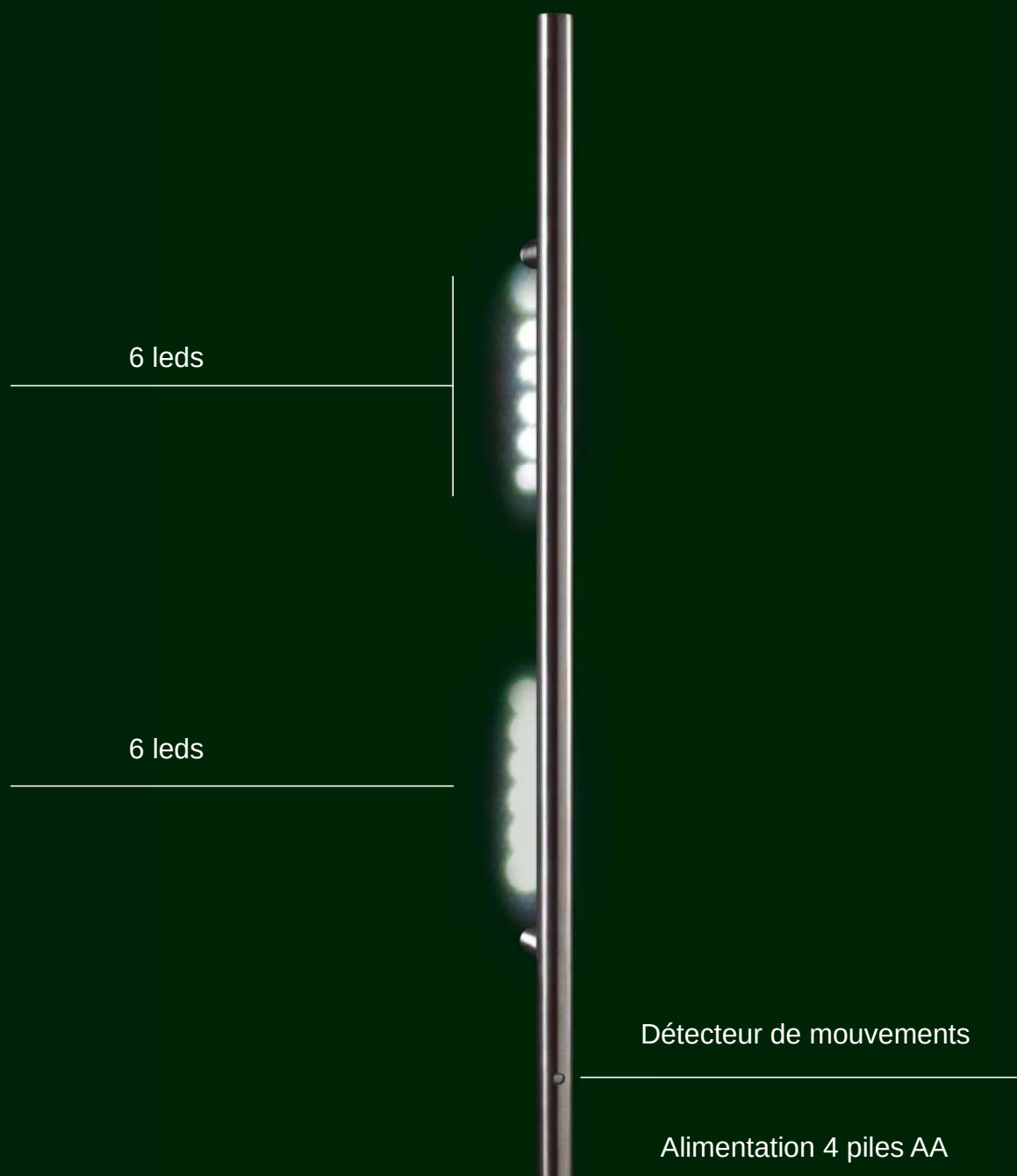

Dimensions :

1800 mm

INVISIBLE vertical

BARRE DE TIRAGE VERTICALE INTÉGRÉE

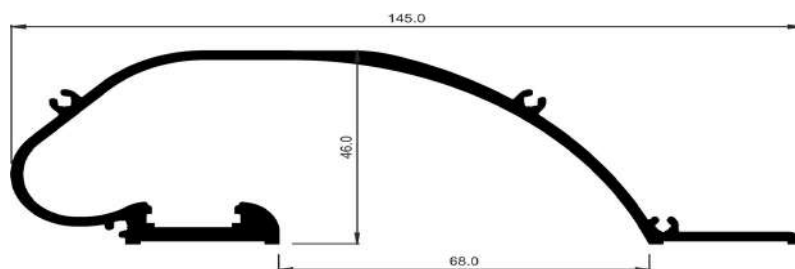

INVISIBLE horizontal

BARRE DE TIRAGE VERTICALE INTÉGRÉE

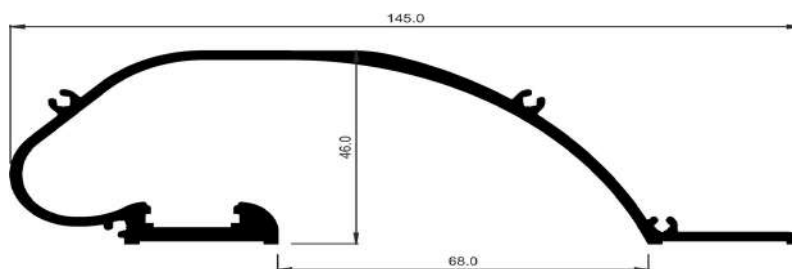

INVISIBLE



Barre de tirage minimaliste
intégrée dans la porte,
possibilité de placée cet
élément sur toute les portes.
Horizontale ou verticale,
avec leds ou sans, laissez
libre court à votre Imagination.

Dimensions :
1800 mm
1200 mm
500 mm



Grille 1



Grille 2



Grille 3



Grille 4



Grille 5



Grille 6



Grille fer forgé



Vitrail plomb 1



Vitrail plomb 2



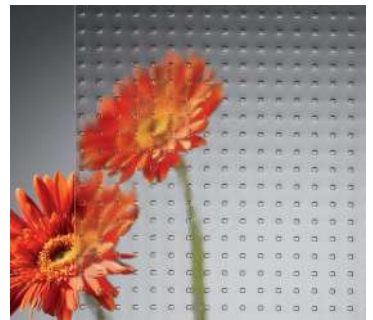
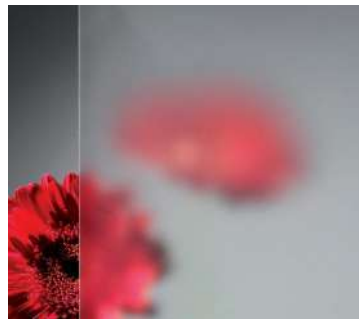
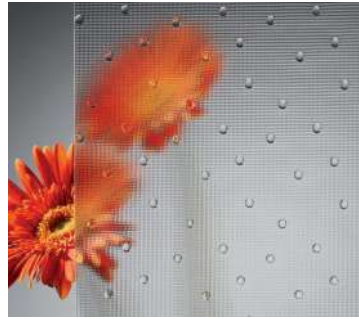
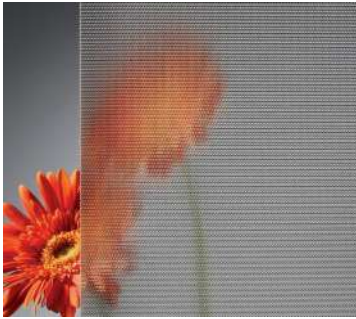

COULEURS



La couleur

“ Nous vous proposons un choix de couleurs ”

Afin d'optimiser son process et de croître en réactivité, **J'AIME MA MAISON** travaille avec une unité de laquage dernière génération qui respecte les normes de respect de environnementales, le tout au normes QUALICOAT, QUALIMARINE, et QUALINODE.

Les laquages 2 finitions

Finition **mate** (inférieure à 40 % de brillance)
Finition **satinée** (60 à 70 % de brillance)



Les laquages fines textures

Une large palette de teintes qui offre une meilleure résistance aux risques de rayures.



La couleur !
Choisissez le savoir-faire
J'AIME MA MAISON !



Couleurs Gamme STANDARD PORTES

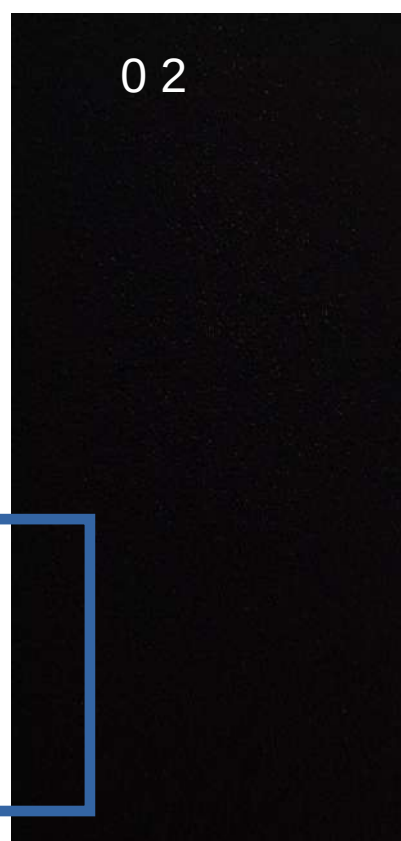
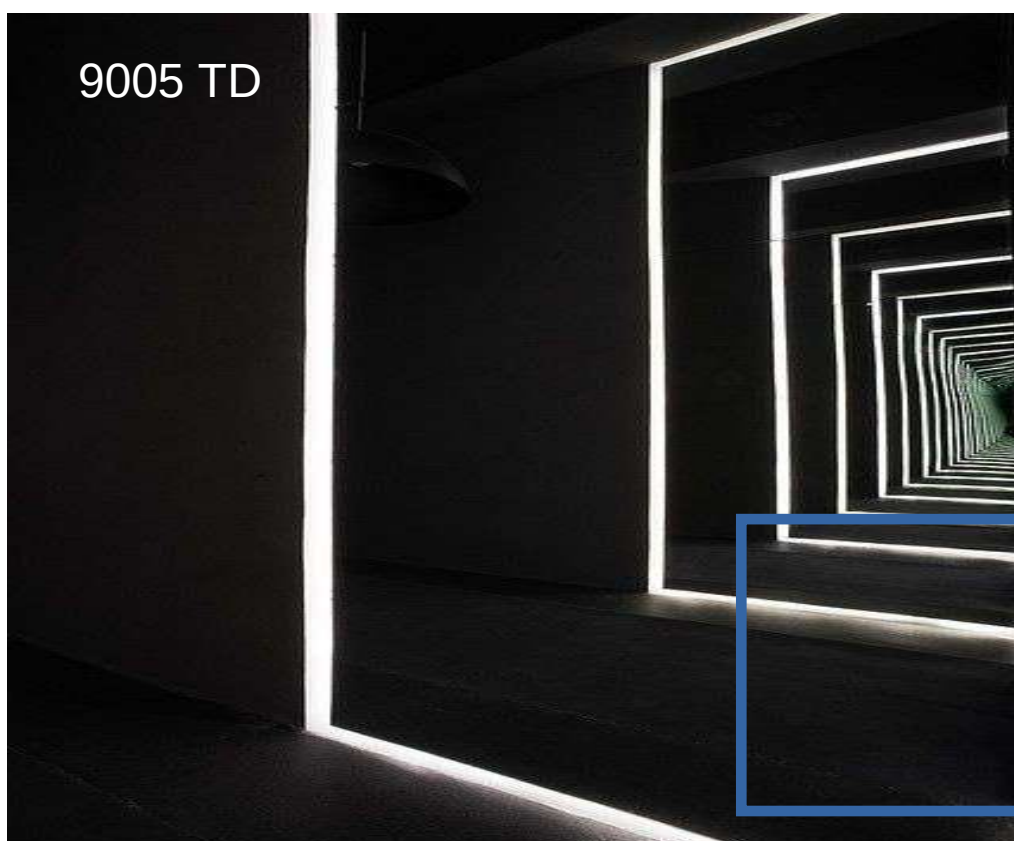
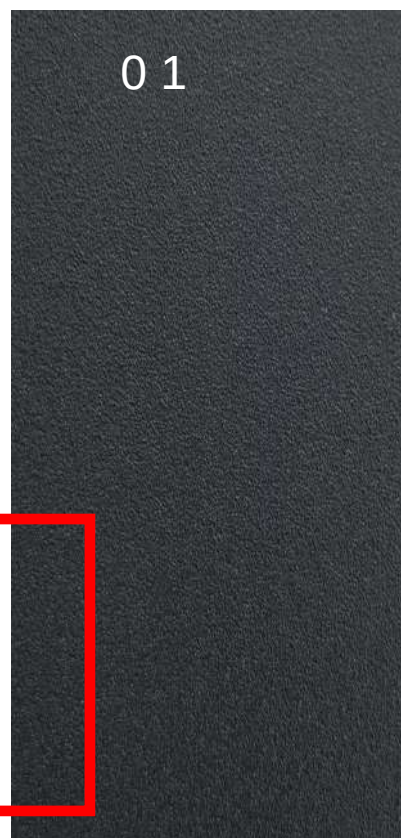

Couleurs Gamme STANDARD PORTES

0 3

7035 TD



0 4

7039 TD

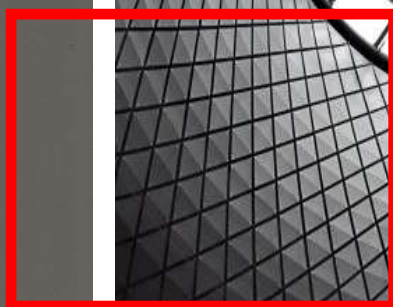

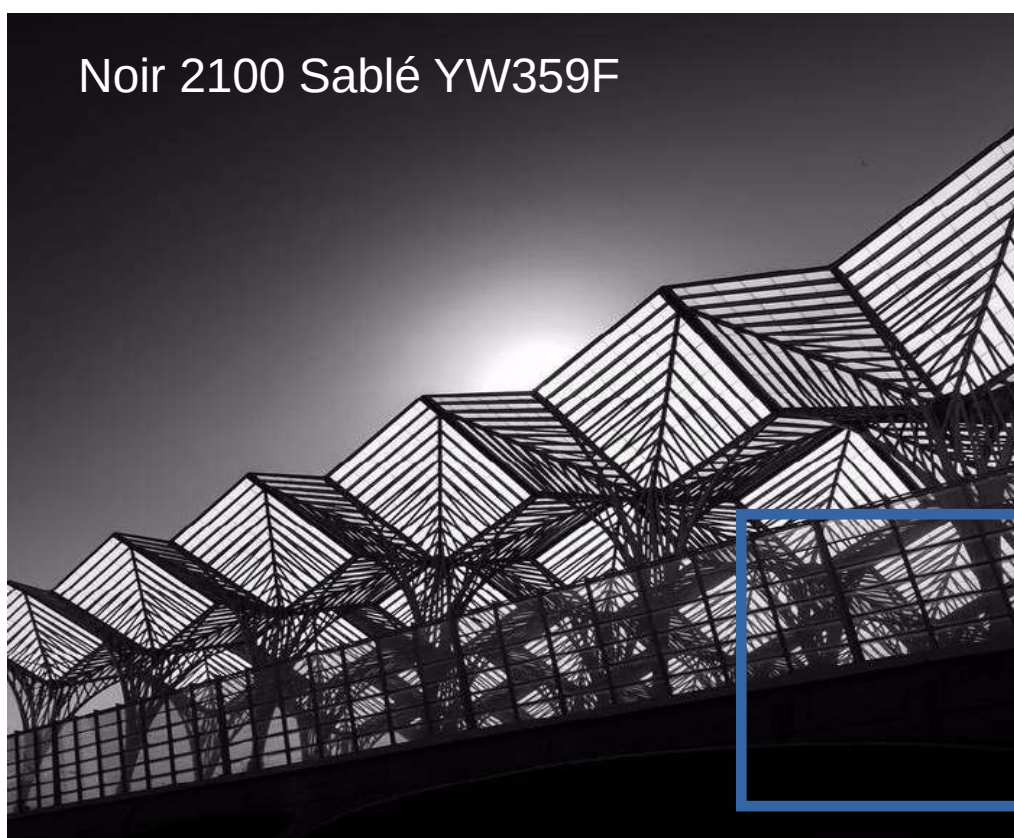
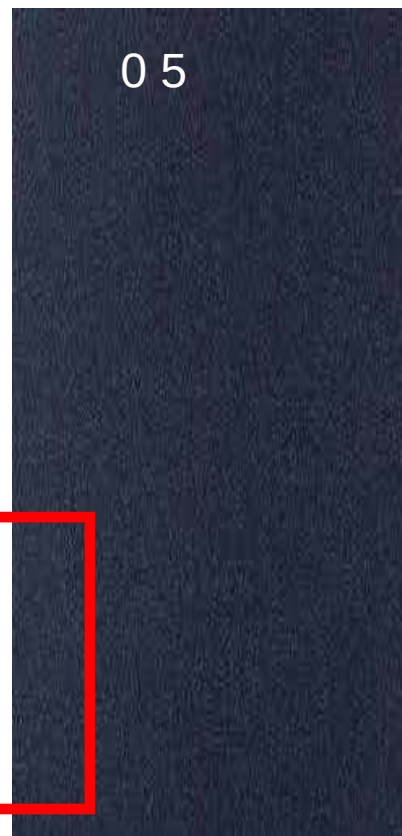

Couleurs Gamme Tendance **PORTES** * AVEC PLUS VALUE

0 7

Gris 2150 Sablé YW365F

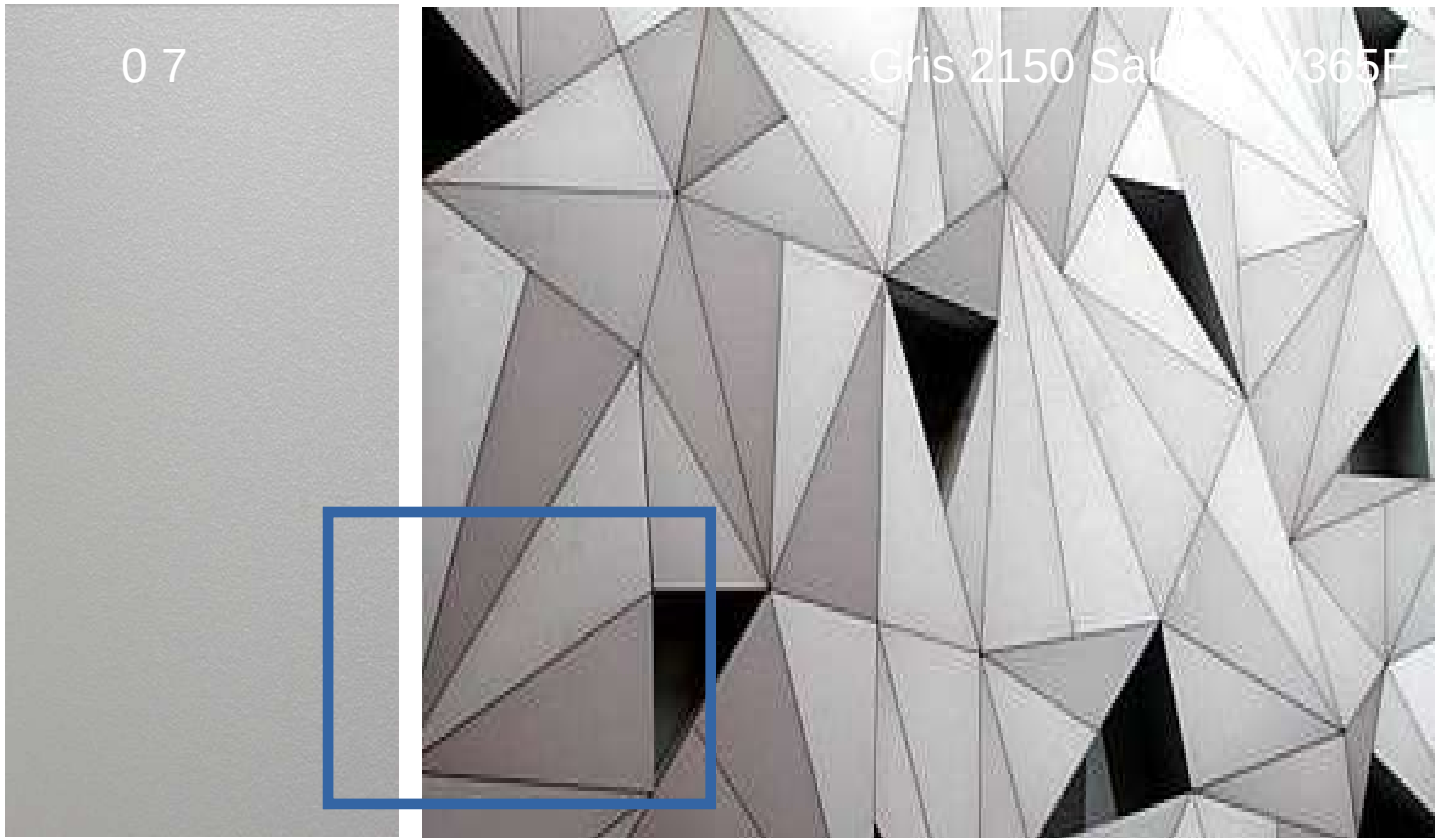

0 8

Brun 2650 Sablé YW366F





J'AIME MA MAISON .com